

TOSHIBA CMOS DIGITAL INTEGRATED CIRCUIT SILICON MONOLITHIC

TC74VCX162821FT**LOW-VOLTAGE 20-BIT D-TYPE FLIP-FLOP
WITH 3.6 V TOLERANT INPUTS AND OUTPUTS**

The TC74VCX162821FT is a high performance CMOS 20-bit D-TYPE FLIP-FLOP. Designed for use in 1.8, 2.5 or 3.3 Volt systems, it achieves high speed operation while maintaining the CMOS low power dissipation.

It is also designed with over voltage tolerant inputs and outputs up to 3.6 V.

The device is byte controlled with each byte functioning identically, but independent of the other. Control pins can be shorted together to obtain full 20-bit operation. The following description applies to each byte. The twenty flip-flops will store the state of their individual D inputs that meet the setup and hold time requirements on the LOW-to-HIGH Clock (CK) transition.

When the \overline{OE} input is high, the outputs are in a high impedance state. This device is designed to be used with 3-state memory address drivers, etc.

The 26- Ω series resistor helps reducing output overshoot and undershoot without external resistor. All inputs are equipped with protection circuits against static discharge.

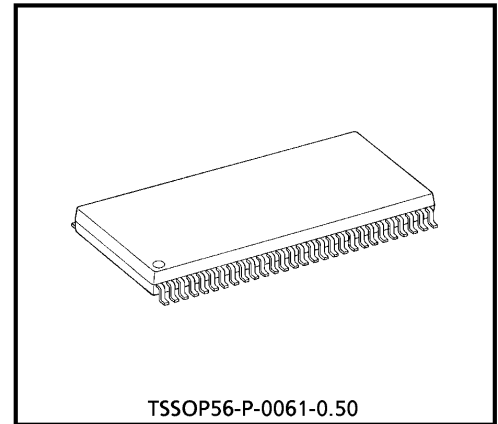

Weight : 0.25 g (Typ.)

FEATURES

- 26- Ω Series Resistors on Outputs.
- Low Voltage Operation : $V_{CC} = 1.8\sim 3.6\text{ V}$
- High Speed Operation : $t_{pd} = 4.4\text{ ns (max) at } V_{CC} = 3.0\sim 3.6\text{ V}$
: $t_{pd} = 5.8\text{ ns (max) at } V_{CC} = 2.3\sim 2.7\text{ V}$
: $t_{pd} = 9.8\text{ ns (max) at } V_{CC} = 1.8\text{ V}$
- 3.6V Tolerant inputs and outputs.
- Output Current : $I_{OH}/I_{OL} = \pm 12\text{ mA (min) at } V_{CC} = 3.0\text{ V}$
: $I_{OH}/I_{OL} = \pm 8\text{ mA (min) at } V_{CC} = 2.3\text{ V}$
: $I_{OH}/I_{OL} = \pm 4\text{ mA (min) at } V_{CC} = 1.8\text{ V}$
- Latch-up Performance : $\pm 300\text{ mA}$
- ESD Performance : Human Body Model $> \pm 2000\text{ V}$
: Machine Model $> \pm 200\text{ V}$
- Package : TSSOP
(Thin Shrink Small Outline Package)
- Power Down Protection is provided on all inputs and outputs.
- Supports live insertion / withdrawal (Note 1)

(Note 1) : To ensure the high-impedance state during power up or power down, \overline{OE} should be tied to V_{CC} through a pullup resistor; the minimum value of the resistor is determined by the current-sourcing capability of the driver.

980910EBA2

● TOSHIBA is continually working to improve the quality and the reliability of its products. Nevertheless, semiconductor devices in general can malfunction or fail due to their inherent electrical sensitivity and vulnerability to physical stress. It is the responsibility of the buyer, when utilizing TOSHIBA products, to observe standards of safety, and to avoid situations in which a malfunction or failure of a TOSHIBA product could cause loss of human life, bodily injury or damage to property. In developing your designs, please ensure that TOSHIBA products are used within specified operating ranges as set forth in the most recent products specifications. Also, please keep in mind the precautions and conditions set forth in the TOSHIBA Semiconductor Reliability Handbook.

PIN ASSIGNMENT

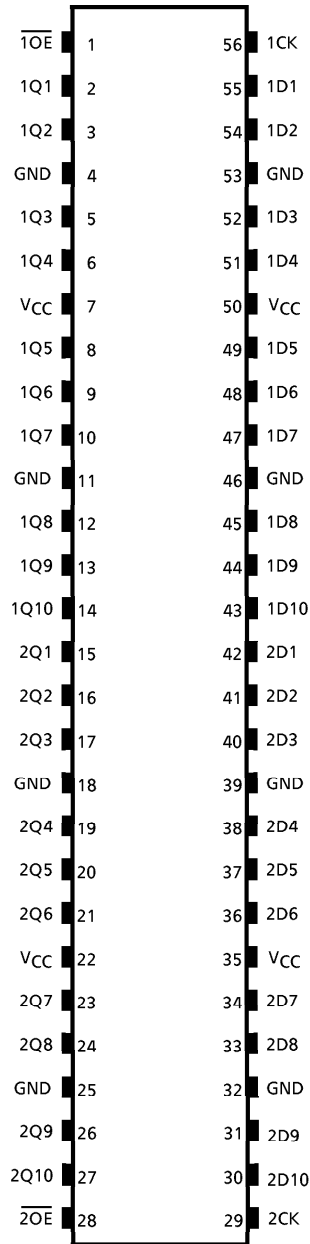

(TOP VIEW)

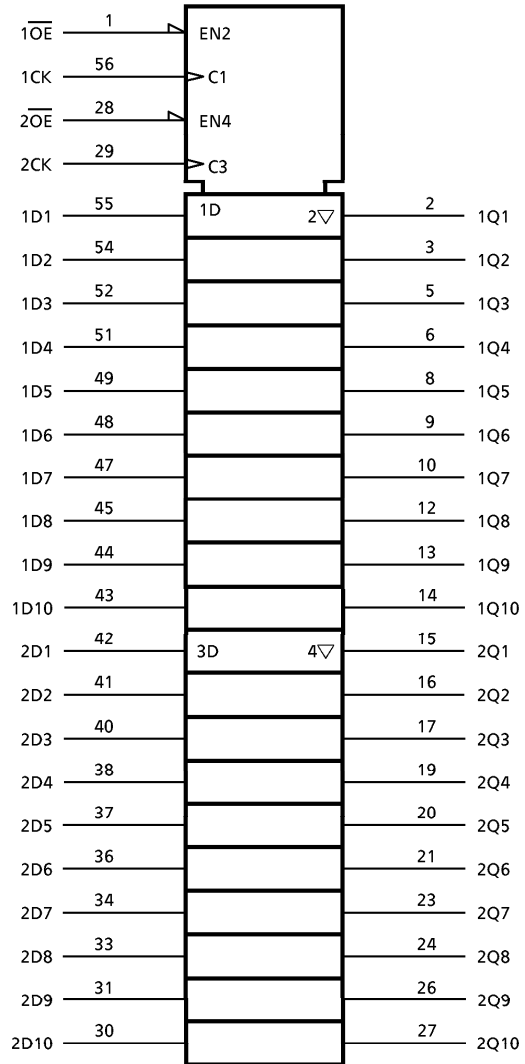

SYMBOL





980910EBA2'

- The products described in this document are subject to the foreign exchange and foreign trade laws.
- The information contained herein is presented only as a guide for the applications of our products. No responsibility is assumed by TOSHIBA CORPORATION for any infringements of intellectual property or other rights of the third parties which may result from its use. No license is granted by implication or otherwise under any intellectual property or other rights of TOSHIBA CORPORATION or others.
- The information contained herein is subject to change without notice.

TRUTH TABLE

INPUT			OUTPUT
1OE	1CK	1D1-1D10	1Q1-1Q10
H	X	X	Z
L		X	Qn
L		L	L
L		H	H

INPUT			OUTPUT
2OE	2CK	2D1-2D10	2Q1-2Q10
H	X	X	Z
L		X	Qn
L		L	L
L		H	H

X : Don't Care
 Z : High impedance
 Qn : No change

SYSTEM DIAGRAM

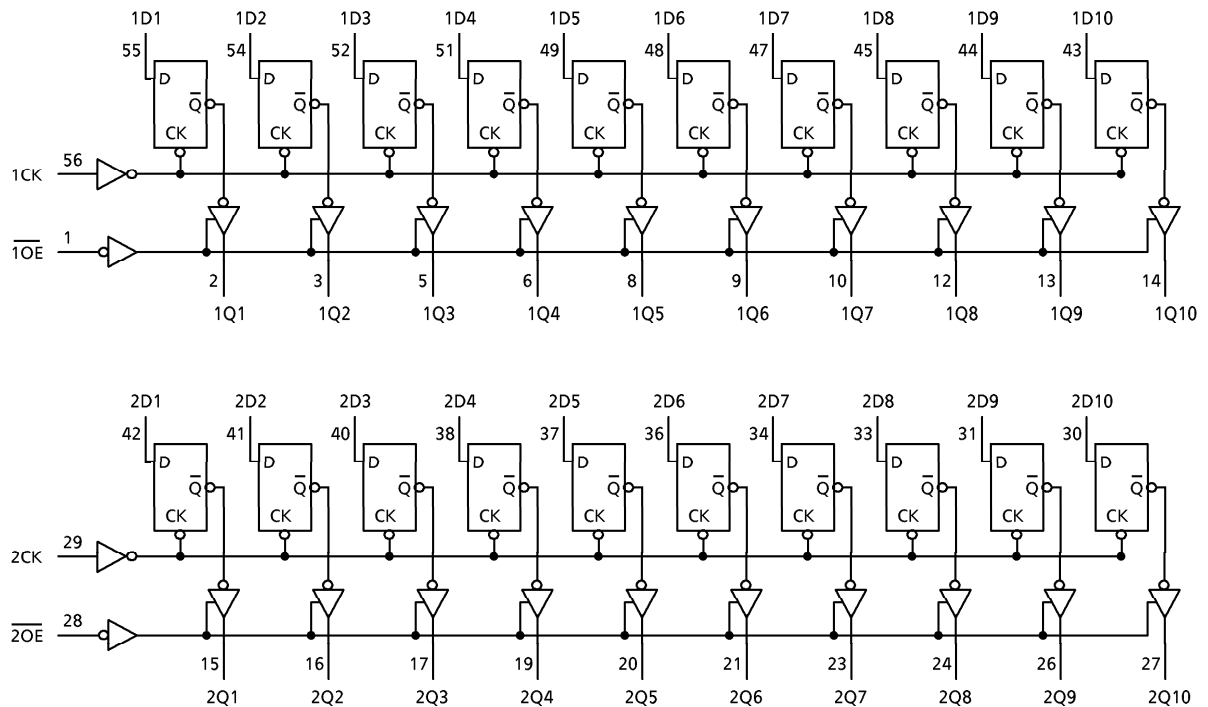

MAXIMUM RATINGS

PARAMETER	SYMBOL	RATING	UNIT
Power Supply Voltage	V_{CC}	- 0.5~4.6	V
DC Input Voltage	V_{IN}	- 0.5~4.6	V
DC Output Voltage	V_{OUT}	- 0.5~4.6 (Note 1)	V
		- 0.5~ V_{CC} + 0.5 (Note 2)	
Input Diode Current	I_{IK}	- 50	mA
Output Diode Current	I_{OK}	\pm 50 (Note 3)	mA
DC Output Current	I_{OUT}	\pm 50	mA
Power Dissipation	P_D	400	mW
DC V_{CC} / Ground Current Per Supply Pin	I_{CC} / I_{GND}	\pm 100	mA
Storage Temperature	T_{stg}	- 65~150	$^{\circ}$ C

(Note 1) : Off-State

(Note 2) : High or Low State. I_{OUT} absolute maximum rating must be observed.

(Note 3) : $V_{OUT} < GND$, $V_{OUT} > V_{CC}$

RECOMMENDED OPERATING RANGE

PARAMETER	SYMBOL	RATING	UNIT
Supply Voltage	V_{CC}	1.8~3.6	V
		1.2~3.6 (Note 4)	
Input Voltage	V_{IN}	- 0.3~3.6	V
Output Voltage	V_{OUT}	0~3.6 (Note 5)	V
		0~ V_{CC} (Note 6)	
Output Current	I_{OH} / I_{OL}	\pm 12 (Note 7)	mA
		\pm 8 (Note 8)	
		\pm 4 (Note 9)	
Operating Temperature	T_{opr}	- 40~85	$^{\circ}$ C
Input Rise And Fall Time	dt / dv	0~10 (Note 10)	ns / V

(Note 4) : Data Retention Only

(Note 5) : Off-State

(Note 6) : High or Low State

(Note 7) : $V_{CC} = 3.0\sim 3.6$ V

(Note 8) : $V_{CC} = 2.3\sim 2.7$ V

(Note 9) : $V_{CC} = 1.8$ V

(Note 10) : $V_{IN} = 0.8\sim 2.0$ V, $V_{CC} = 3.0$ V

ELECTRICAL CHARACTERISTICS

DC characteristics (Ta = -40~85°C, 2.7 V < V_{CC} ≤ 3.6 V)

PARAMETER		SYMBOL	TEST CONDITION		V _{CC} (V)	MIN	MAX	UNIT
Input Voltage	"H" Level	V _{IH}			2.7~3.6	2.0	—	V
	"L" Level	V _{IL}			2.7~3.6	—	0.8	V
Output Voltage	"H" Level	V _{OH}	V _{IN} = V _{IH} or V _{IL}	I _{OH} = -100 μA	2.7~3.6	V _{CC} - 0.2	—	V
				I _{OH} = -6 mA	2.7	2.2	—	
				I _{OH} = -8 mA	3.0	2.4	—	
				I _{OH} = -12 mA	3.0	2.2	—	
	"L" Level	V _{OL}	V _{IN} = V _{IH} or V _{IL}	I _{OL} = 100 μA	2.7~3.6	—	0.2	V
				I _{OL} = 6 mA	2.7	—	0.4	
				I _{OL} = 8 mA	3.0	—	0.55	
				I _{OL} = 12 mA	3.0	—	0.8	
Input Leakage Current		I _{IN}	V _{IN} = 0~3.6 V		2.7~3.6	—	± 5.0	μA
3-State Output Off-State Current		I _{OZ}	V _{IN} = V _{IH} or V _{IL} V _{OUT} = 0~3.6 V		2.7~3.6	—	± 10.0	μA
Power Off Leakage Current		I _{OFF}	V _{IN} , V _{OUT} = 0~3.6 V		0	—	10.0	μA
Quiescent Supply Current		I _{CC}	V _{IN} = V _{CC} or GND		2.7~3.6	—	20.0	μA
			V _{CC} ≤ (V _{IN} , V _{OUT}) ≤ 3.6 V		2.7~3.6	—	± 20.0	
Increase In I _{CC} Per Input		ΔI _{CC}	V _{IH} = V _{CC} - 0.6 V		2.7~3.6	—	750	μA

ELECTRICAL CHARACTERISTICS

DC characteristics (Ta = -40~85°C, 2.3 V ≤ VCC ≤ 2.7 V)

PARAMETER		SYMBOL	TEST CONDITION		VCC (V)	MIN	MAX	UNIT
					2.3~2.7			
Input Voltage	"H" Level	V _{IH}			2.3~2.7	1.6	—	V
	"L" Level	V _{IL}			2.3~2.7	—	0.7	V
Output Voltage	"H" Level	V _{OH}	V _{IN} = V _{IH} or V _{IL}	I _{OH} = -100 μA	2.3~2.7	V _{CC} - 0.2	—	V
				I _{OH} = -4 mA	2.3	2.0	—	
				I _{OH} = -6 mA	2.3	1.8	—	
				I _{OH} = -8 mA	2.3	1.7	—	
	"L" Level	V _{OL}	V _{IN} = V _{IH} or V _{IL}	I _{OL} = 100 μA	2.3~2.7	—	0.2	V
				I _{OL} = 6 mA	2.3	—	0.4	
I _{OL} = 8 mA				2.3	—	0.6		
Input Leakage Current		I _{IN}	V _{IN} = 0~3.6 V		2.3~2.7	—	± 5.0	μA
3-State Output Off-State Current		I _{OZ}	V _{IN} = V _{IH} or V _{IL} V _{OUT} = 0~3.6 V		2.3~2.7	—	± 10.0	μA
Power Off Leakage Current		I _{OFF}	V _{IN} , V _{OUT} = 0~3.6 V		0	—	10.0	μA
Quiescent Supply Current		I _{CC}	V _{IN} = V _{CC} or GND		2.3~2.7	—	20.0	μA
			V _{CC} ≤ (V _{IN} , V _{OUT}) ≤ 3.6 V		2.3~2.7	—	± 20.0	

ELECTRICAL CHARACTERISTICS

DC characteristics (Ta = -40~85°C, 1.8 V ≤ VCC < 2.3 V)

PARAMETER		SYMBOL	TEST CONDITION		VCC (V)	MIN	MAX	UNIT
					1.8~2.3			
Input Voltage	"H" Level	V _{IH}			1.8~2.3	0.7 × V _{CC}	—	V
	"L" Level	V _{IL}			1.8~2.3	—	0.2 × V _{CC}	V
Output Voltage	"H" Level	V _{OH}	V _{IN} = V _{IH} or V _{IL}	I _{OH} = -100 μA	1.8	V _{CC} - 0.2	—	V
				I _{OH} = -4 mA	1.8	1.4	—	
	"L" Level	V _{OL}	V _{IN} = V _{IH} or V _{IL}	I _{OL} = 100 μA	1.8	—	0.2	V
				I _{OL} = 4 mA	1.8	—	0.3	
Input Leakage Current		I _{IN}	V _{IN} = 0~3.6 V		1.8	—	± 5.0	μA
3-State Output Off-State Current		I _{OZ}	V _{IN} = V _{IH} or V _{IL} V _{OUT} = 0~3.6 V		1.8	—	± 10.0	μA
Power Off Leakage Current		I _{OFF}	V _{IN} , V _{OUT} = 0~3.6 V		0	—	10.0	μA
Quiescent Supply Current		I _{CC}	V _{IN} = V _{CC} or GND		1.8	—	20.0	μA
			V _{CC} ≤ (V _{IN} , V _{OUT}) ≤ 3.6 V		1.8	—	± 20.0	

AC characteristics (Ta = -40~85°C, Input tr = tf = 2.0 ns, CL = 30 pF, RL = 500 Ω)

PARAMETER	SYMBOL	TEST CONDITION	VCC (V)	MIN	MAX	UNIT
Maximum Clock Frequency	fMAX	(Fig.1, 2)	1.8	100	—	MHz
			2.5 ± 0.2	200	—	
			3.3 ± 0.3	250	—	
Propagation Delay Time (CK-Q)	tpLH tpHL	(Fig.1, 2)	1.8	1.5	9.8	ns
			2.5 ± 0.2	0.8	5.8	
			3.3 ± 0.3	0.6	4.4	
3-State Output Enable Time	tpZL tpZH	(Fig.1, 3)	1.8	1.5	9.8	ns
			2.5 ± 0.2	0.8	5.7	
			3.3 ± 0.3	0.6	4.2	
3-State Output Disable Time	tpLZ tpHZ	(Fig.1, 3)	1.8	1.5	8.8	ns
			2.5 ± 0.2	0.8	4.9	
			3.3 ± 0.3	0.6	4.2	
Minimum Pulse Width (CK)	tw (H) tw (L)	(Fig.1, 2)	1.8	4.0	—	ns
			2.5 ± 0.2	1.5	—	
			3.3 ± 0.3	1.5	—	
Minimum Set-up Time	ts	(Fig.1, 2)	1.8	2.5	—	ns
			2.5 ± 0.2	1.5	—	
			3.3 ± 0.3	1.5	—	
Minimum Hold Time	th	(Fig.1, 2)	1.8	1.0	—	ns
			2.5 ± 0.2	1.0	—	
			3.3 ± 0.3	1.0	—	
Output to Output Skew	tosLH tosHL	(Note 11)	1.8	—	0.5	ns
			2.5 ± 0.2	—	0.5	
			3.3 ± 0.3	—	0.5	

For CL = 50 pF, add approximately 300 ps to the AC maximum specification.

(Note 11) : Parameter guaranteed by design.

$$(tosLH = |tpLHm - tpLHn|, tosHL = |tpHLm - tpHLn|)$$

Dynamic switching characteristics (Ta = 25°C, Input tr = tf = 2.0 ns, CL = 30 pF)

PARAMETER	SYMBOL	TEST CONDITION	VCC (V)	TYP.	UNIT
Quiet Output Maximum Dynamic VOL	VOLP	V _{IH} = 1.8 V, V _{IL} = 0 V (Note 12)	1.8	0.15	V
		V _{IH} = 2.5 V, V _{IL} = 0 V (Note 12)	2.5	0.25	
		V _{IH} = 3.3 V, V _{IL} = 0 V (Note 12)	3.3	0.35	
Quiet Output Minimum Dynamic VOL	VOLV	V _{IH} = 1.8 V, V _{IL} = 0 V (Note 12)	1.8	-0.15	V
		V _{IH} = 2.5 V, V _{IL} = 0 V (Note 12)	2.5	-0.25	
		V _{IH} = 3.3 V, V _{IL} = 0 V (Note 12)	3.3	-0.35	
Quiet Output Minimum Dynamic VOH	VOHV	V _{IH} = 1.8 V, V _{IL} = 0 V (Note 12)	1.8	1.55	V
		V _{IH} = 2.5 V, V _{IL} = 0 V (Note 12)	2.5	2.05	
		V _{IH} = 3.3 V, V _{IL} = 0 V (Note 12)	3.3	2.65	

(Note 12) : Parameter guaranteed by design.

Capacitive characteristics (Ta = 25°C)

PARAMETER	SYMBOL	TEST CONDITION	VCC (V)	TYP.	UNIT
Input Capacitance	C _{IN}		1.8, 2.5, 3.3	6	pF
Output Capacitance	C _O		1.8, 2.5, 3.3	7	pF
Power Dissipation Capacitance	C _{PD}	f _{IN} = 10 MHz (Note 13)	1.8, 2.5, 3.3	20	pF

(Note 13) : C_{PD} is defined as the value of the internal equivalent capacitance which is calculated from the operating current consumption without load.

Average operating current can be obtained by the equation :

$$I_{CC}(\text{opr.}) = C_{PD} \cdot V_{CC} \cdot f_{IN} + I_{CC}/20 \text{ (per bit)}$$

TEST CIRCUIT
Fig.1

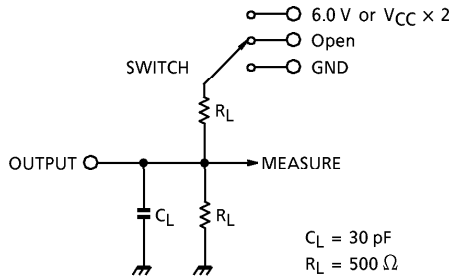

PARAMETER	SWITCH
t_{pLH}, t_{pHL}	Open
t_{pLZ}, t_{pZL}	6.0 V @ $V_{CC} = 3.3 \pm 0.3 \text{ V}$ $V_{CC} \times 2$ @ $V_{CC} = 2.5 \pm 0.2 \text{ V}$ @ $V_{CC} = 1.8 \text{ V}$
t_{pHZ}, t_{pZH}	GND

AC WAVEFORM

Fig.2 $t_{pLH}, t_{pHL}, t_w, t_s, t_h$

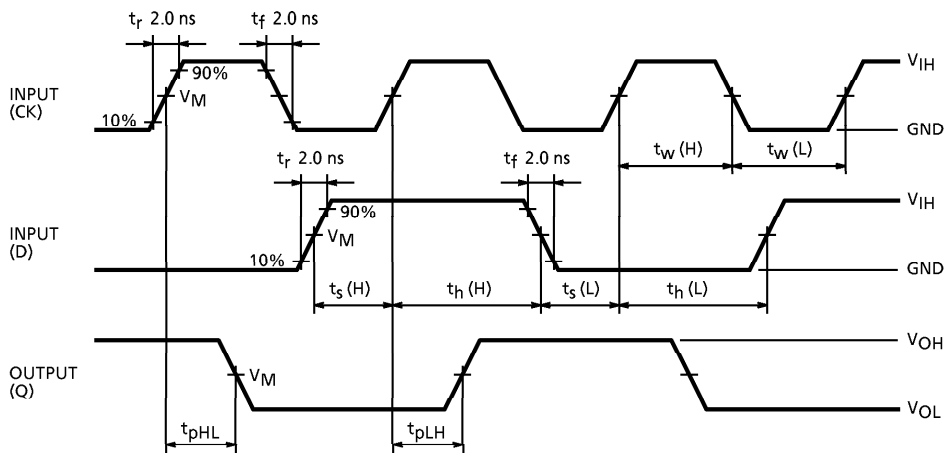
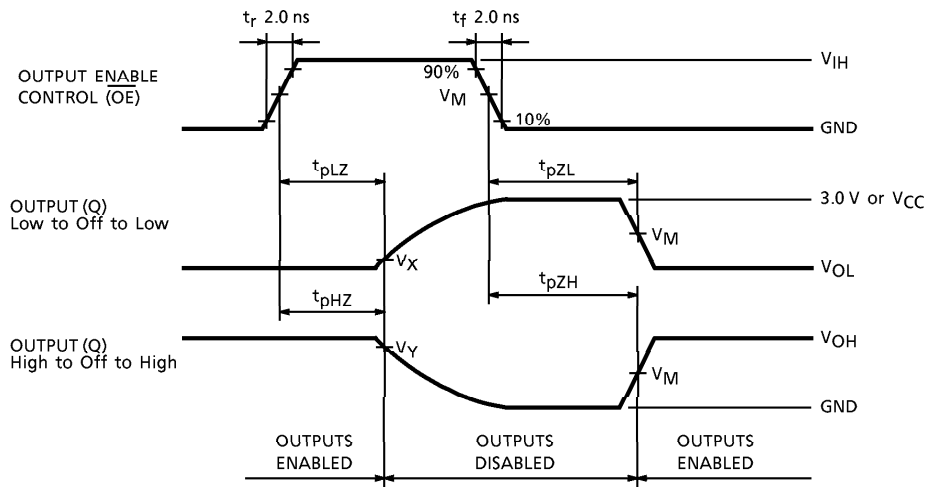

Fig.3 t_{pLZ} , t_{pHZ} , t_{pZL} , t_{pZH}



SYMBOL	V_{CC}		
	3.3 ± 0.3 V	2.5 ± 0.2 V	1.8 V
V_{IH}	2.7 V	V_{CC}	V_{CC}
V_M	1.5 V	$V_{CC} / 2$	$V_{CC} / 2$
V_X	$V_{OL} + 0.3$ V	$V_{OL} + 0.15$ V	$V_{OL} + 0.15$ V
V_Y	$V_{OH} - 0.3$ V	$V_{OH} - 0.15$ V	$V_{OH} - 0.15$ V

PACKAGE DIMENSIONS

TSSOP56-P-0061-0.50

Unit : mm

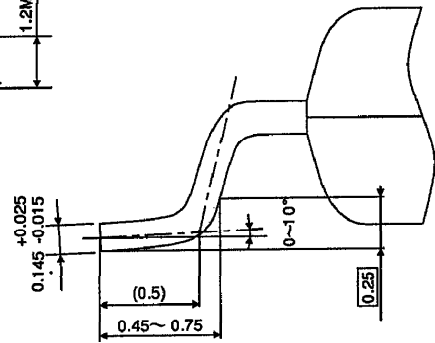
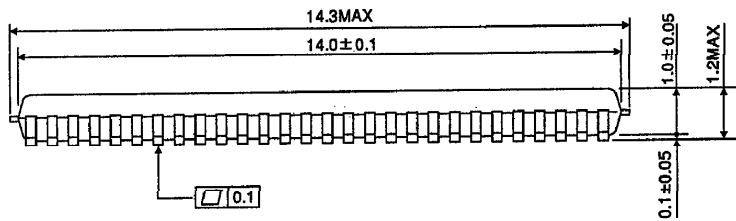
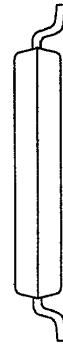
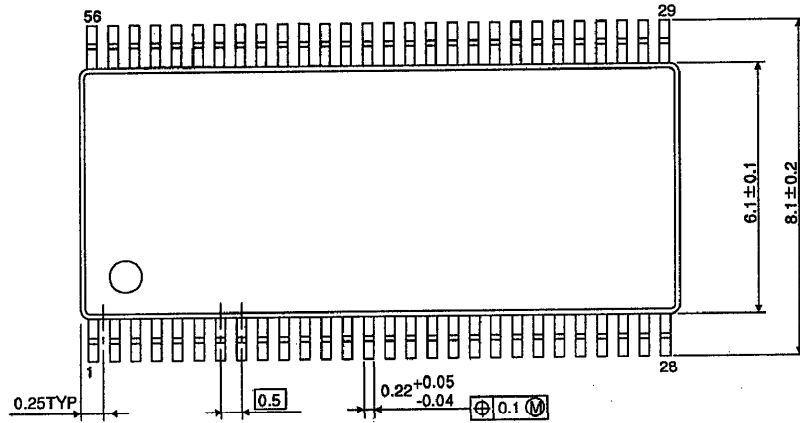

Weight : 0.25 g (Typ.)